

Keysight Technologies PNA Microwave Network Analyzers

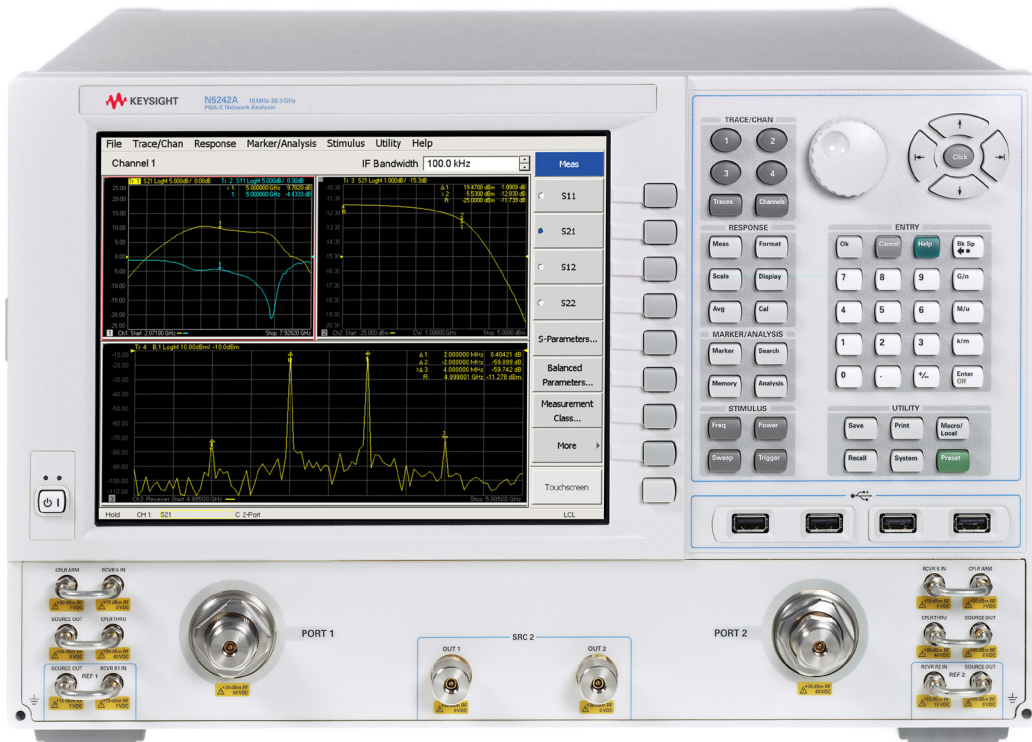

PNA Network Analyzers:
E8362/3/4B, E8361A
10 MHz to 20, 40, 50, 67, or 110 GHz

PNA-L Network Analyzers:
N5230A
300 kHz to 6, 13.5, or 20 GHz
10 MHz to 20, 40, or 50 GHz

PNA-X Network Analyzers:
N5242A
10 MHz to 26.5 GHz

Welcome to The World of PNAs – The Most Popular Microwave Network Analyzers

The PNA Series builds on Keysight Technologies Inc. 40-year legacy of excellence to deliver new standards in speed, accuracy, and versatility for microwave network analysis. The PNA's architecture includes high quality, stable hardware and flexible software. The standard PNA is suitable for testing passive and active devices such as filters and amplifiers. Users can easily add options to test mixers, harmonics, intermodulation distortion (IMD), pulsed-RF, antennas and millimeter-wave (mmwave) components.

Please note: This document does not contain Keysight's most up-to-date PNA Series network analyzer portfolio. This document is available for reference only for customers using Keysight's legacy network analyzers. To view the current Agilent PNA Microwave Network Analyzers brochure [click here](#).

Key features

- Excellent performance
 - High dynamic range: 127 dB at 20 GHz at test port
 - Low trace noise: 0.002 dB rms at 1 kHz bandwidth
 - Fast measurement speed: 4.5 to 26 µsec/point
 - High stability: 0.05 dB/degrees Celsius
- State-of-the-art calibration capabilities and wide-range of ECal modules
- Advanced applications for mixer and pulse measurements
- Single-ended and balanced measurements
- 32 measurement channels, unlimited traces, and 16,001 points per channel
- Connectivity with Open Windows XP, 6 USB connectors, LAN, and GPIB

PNA models

PNA **PNA-L** **PNA-X**

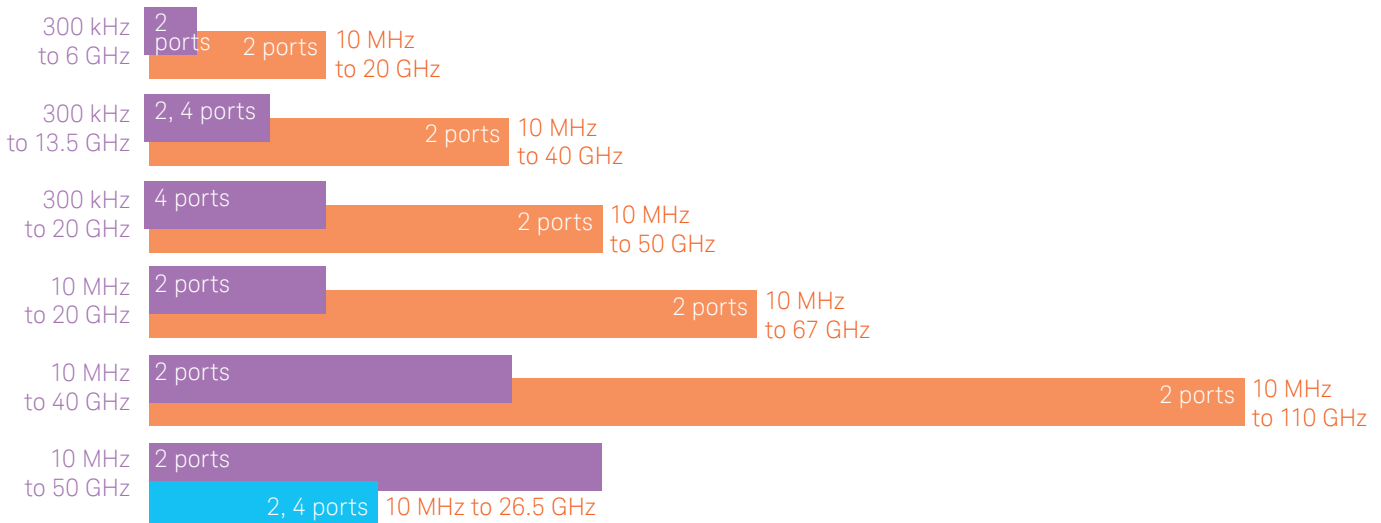

Common Features Across the PNA Series

Flexible user interface:
hard keys, soft keys,
and pull-down menus

Up to
10 markers
per trace

32 measurement
channels and
unlimited traces

State-of-the-art
calibration
capabilities

On-line
Help

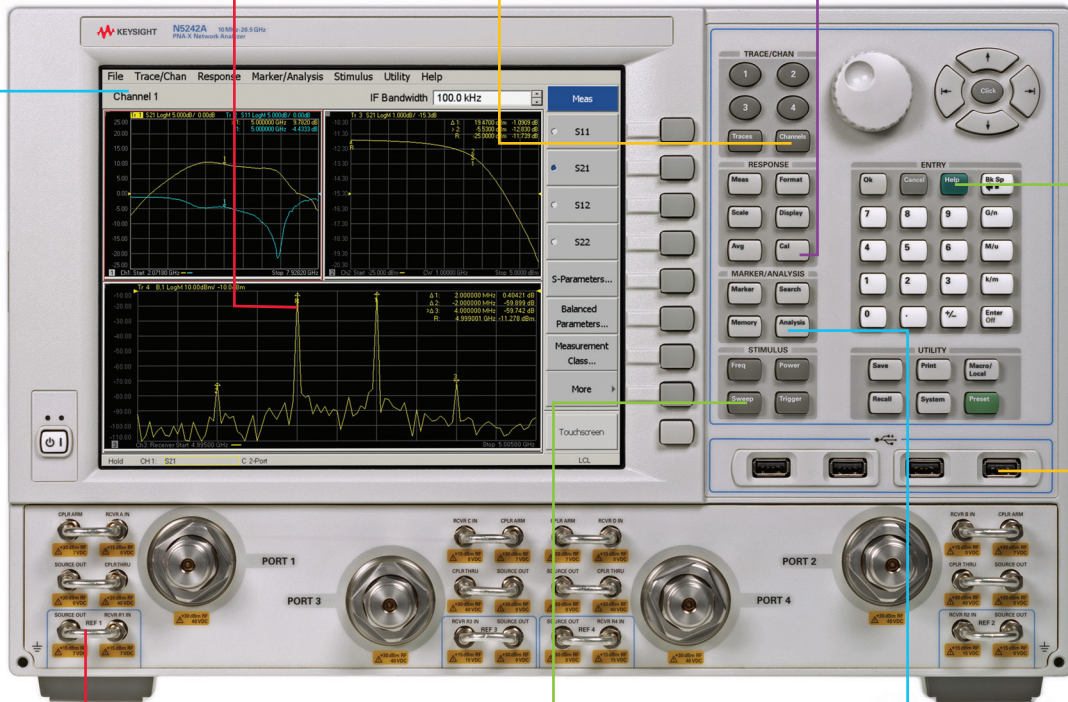

Configurable
test set available
on all models

Linear, log,
power, CW, and
segment sweep

Equation editor
and time-domain
analysis

Quick access
for ECal and other
USB devices

The PNA-X integrates a 10.4 inch high resolution display with a touch screen, which provides a crisp view and easy access to all data and traces. This enhanced user interface allows intuitive operation and helps you set up complex measurements quickly.



PNA-X – The Premier-Performance Microwave Network Analyzer

The industry-leading performance and highly integrated configurable nature of the PNA-X make it the ideal solution to address active device measurement challenges. The PNA-X enables engineers to stay on the leading edge of component testing.

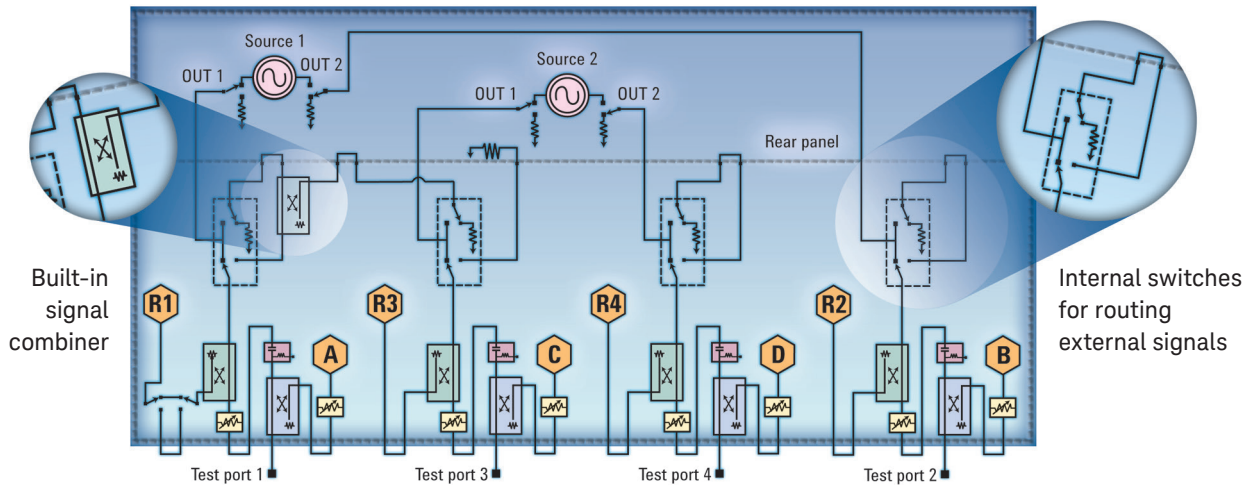

PNA-X block diagram (shown with Options 400, 419, and 423).

High quality synthesizers

- 10 MHz to 26.5 GHz
- Internal 2nd source for IMD, hot-S₂₂, and high speed swept-LO measurements
- High output power and wide power-sweep range for testing amplifiers
- Excellent harmonic performance for accurate harmonic and IMD measurements

Sensitive and linear receivers

- High compression point for improved dynamic accuracy
- More sensitivity for pulsed S-parameter measurements

Friendly user interface

- Large 10.4 inch touch screen display
- Click-and-drag markers and zoom

Exceptional flexibility

- Built-in signal combiner for easy IMD and hot-S₂₂ measurements
- Easy pulsed measurements with internal pulse modulators and pulse generators
- Flexible signal routing via internal switches for adding external filters, pre-amplifiers, and additional test equipment
- Optional noise figure measurement capability extends the suite of measurements available with a single connection and offers the industry's highest accuracy
- Front-panel jumpers for direct access to test-port couplers and receivers
- Source and receiver attenuators with 5 dB increments for better measurement optimization
- Built-in bias-tees simplify amplifier evaluation
- Three sets of triggering lines for complex test systems

PNA-X – Testing Beyond The Limits – Mixers and Converters

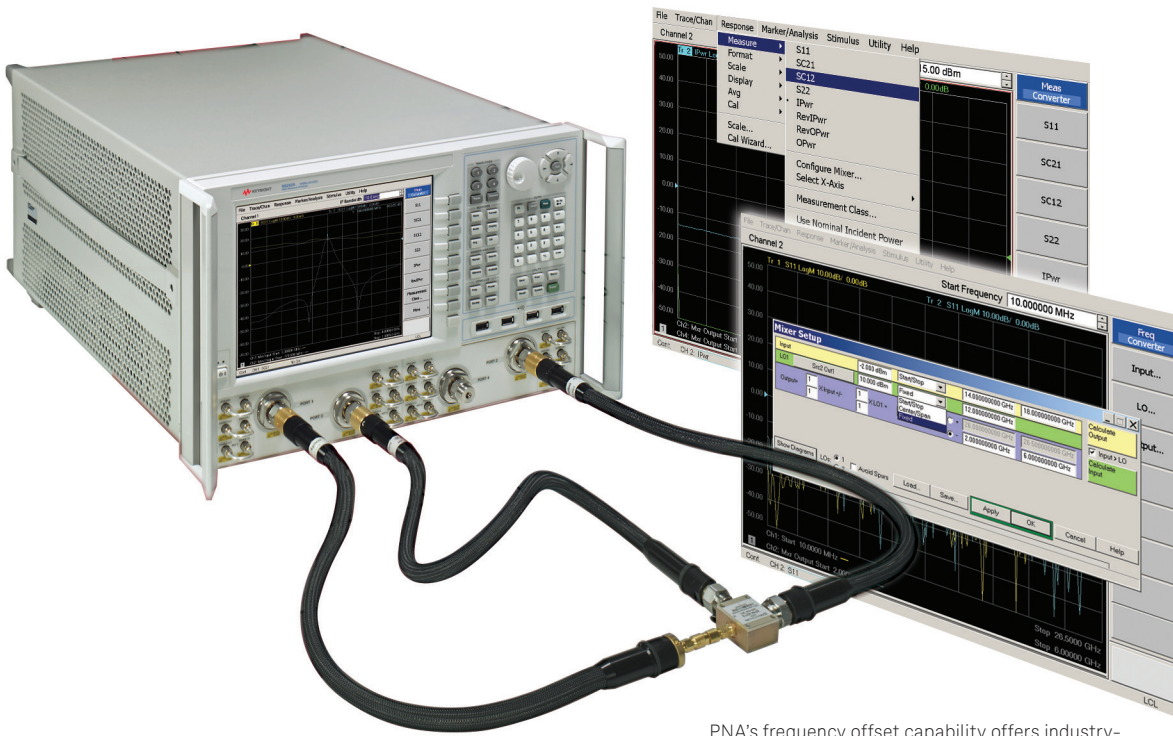

PNA's frequency offset capability offers industry-leading accuracy and ease-of-use for measuring mixers and frequency converters.

Mixer measurements

Checklist

- Conversion loss/gain, magnitude and phase
- Input match, output match, and LO match
- Isolation and compression
- The two internal independent synthesizers with +13 dBm power and < 60 dBc harmonics eliminate the need for external synthesizers or components.
- Advanced error correction
 - Patented vector-mixer calibration for measurement of absolute group delay
 - Scalar-mixer calibration (SMC) for match-corrected amplitude measurements
- Significantly faster speed for fixed-IF (20 to 30 times faster than with an external source)
- Easy-to-configure multi-stage converter measurements
- LO source control and LO power calibration
- Mixer IMD
- The simple two-step SMC calibration provides match-corrected conversion loss, error-corrected input and output match
- Software tuning for embedded LO

PNA-X – Ahead of The Curve – Amplifiers, Pulsed-RF

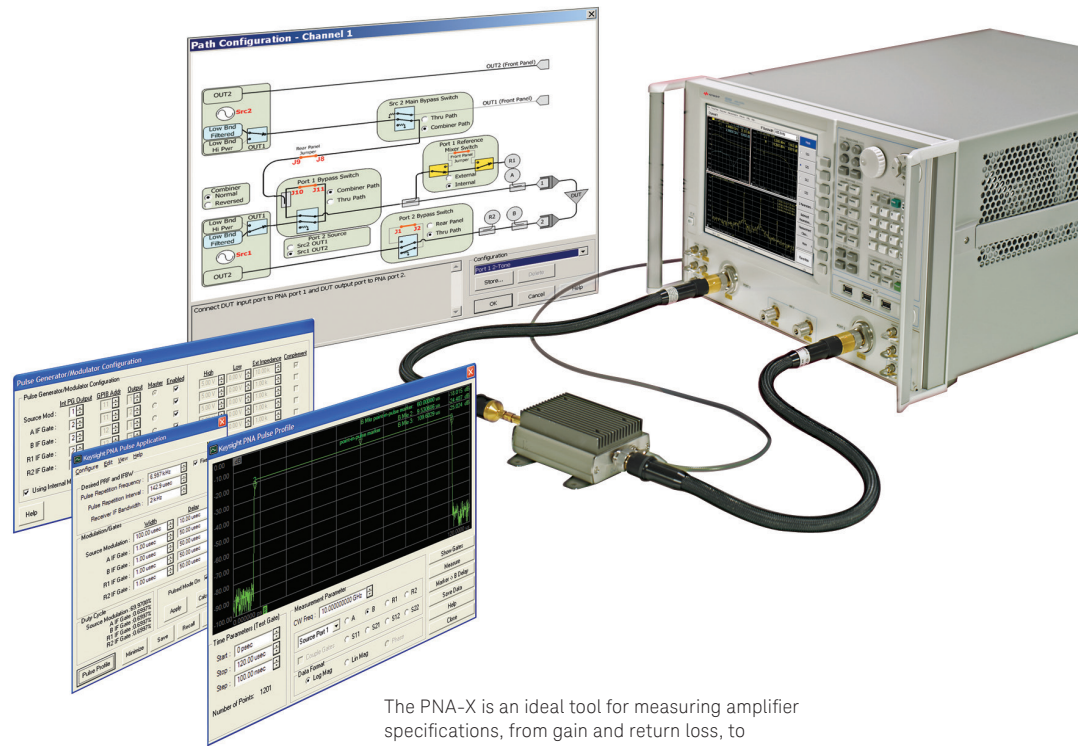

The PNA-X is an ideal tool for measuring amplifier specifications, from gain and return loss, to harmonics and IMD.

Amplifier measurements

Checklist

- Gain, gain flatness, reverse isolation, and return loss
- Simple, fast, and accurate AM-AM and AM-PM compression measurements with the Gain Compression Application with 38 dB power sweep range at 20 GHz, +13 dBm output power
- Test harmonics accurately with < 60 dBc source harmonics. No need for external filters.
- Accurate and simple IMD using the dual sources and internal combiner, located behind the couplers, providing highly accurate and stable measurements. No need for external combiners.
- Source corrected noise figure measurements with exceptional accuracy
- Integrated source attenuators and receiver attenuators for measurement optimization
- Perform all of the above measurements with one single connection using the PNA-X.

Pulsed-RF measurements

Checklist

- Wideband and narrowband detection
- Up to four internal pulse generators
- Up to two internal pulse modulators
- Pulse widths as narrow as 33 ns
- Pulse-to-pulse
- Point-in-pulse, average pulse, and pulse-profile capability
- No need for external components

The Keysight PNA-L is designed for your general-purpose network analysis needs and priced for your budget. With the same firmware as the PNA, the PNA-L offers the perfect balance of value and performance. PNA-L provides efficiency and flexibility in both manufacturing and R&D applications, for industries ranging from wireless LAN component production to aerospace and defense.

Basic measurements

Checklist

- Insertion loss, gain, return loss, isolation, group delay, compression, both magnitude and phase
- Connectorized, in-fixture, or on-wafer
- Fast and accurate
- Reliable and repeatable
- Affordable

On-wafer measurements

Checklist

- Class of TRL calibrations for accurate measurements
- Differential measurement capabilities with integrated multiport network analyzers
- Accurate power control and de-embedding algorithm for device characterization
- Compatibility with on-wafer calibration software for a total solution

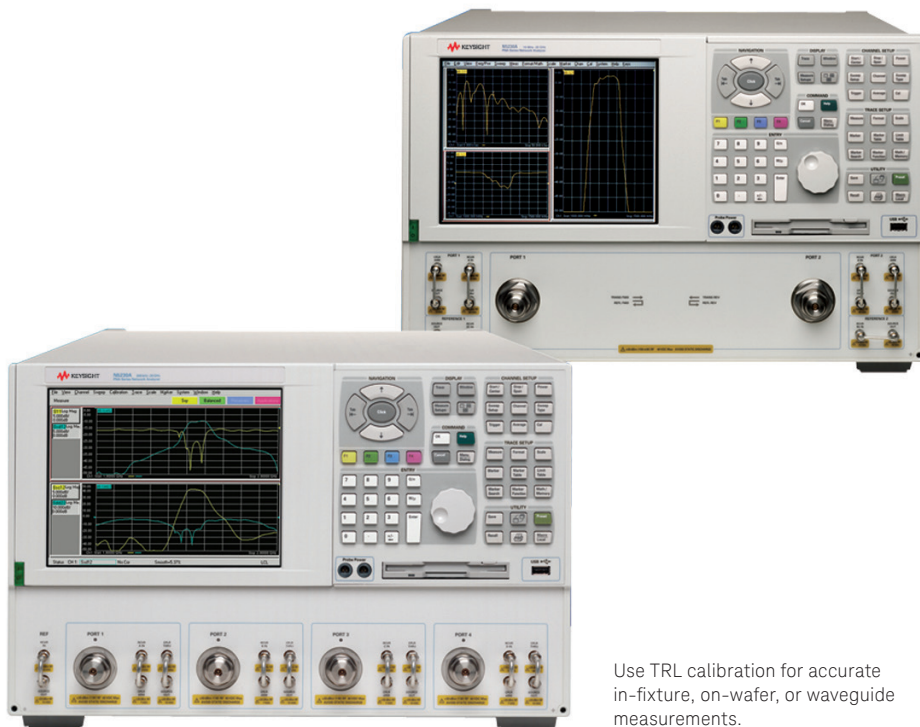
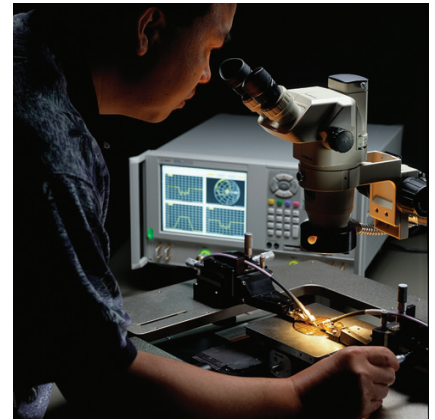

Use TRL calibration for accurate in-fixture, on-wafer, or waveguide measurements.

PNA-L – Speed and Accuracy You Can Count On – Balanced/Differential Measurements and Multiport Test

Easily measure single-ended, balanced, and mixed-mode S-parameters, in addition to ratioed and unratioed receiver measurements.

New multiport components require complicated test plans. Multiple port combinations must be tested over several frequency bands, resulting in lengthy tests. To reduce test time and lower costs, the PNA-L/PNA-X and test set combinations have been designed for high-speed measurements. To further simplify complex test requirements, up to 32 independent channels are available, eliminating the need for recalling instrument states.

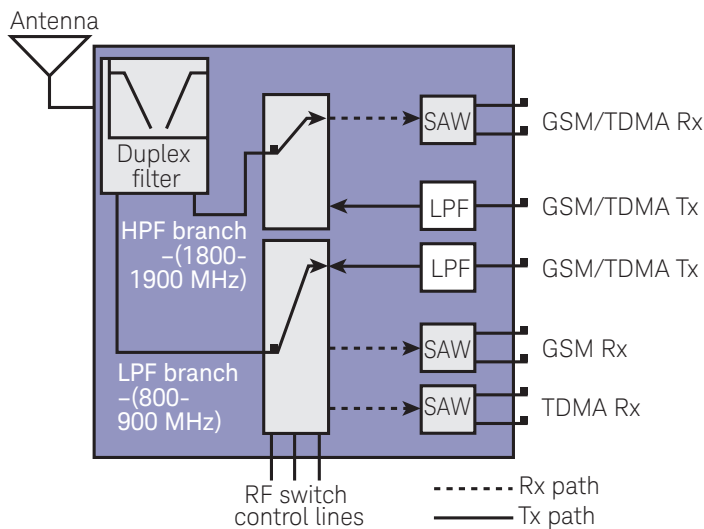

Tri-band antenna switch module with balanced and single-ended ports.

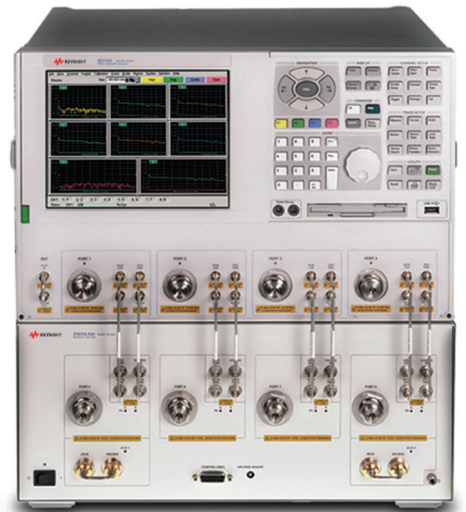

Adding a 4-port test set expands the 4-port PNA-L to an 8-port system with full 8-port measurement capabilities.

Differential measurements

Checklist

- Single-ended, balanced, mixed-mode
- S-parameters
- Ratioed and unratioed measurements
- Mode-conversion analysis
- True-mode stimulus measurements

Multiport measurements

Checklist

- Multiport configurations optimized for your device, including full cross-bar
- Quick-Short-Open-Load-Thru (QSOLT) for fast, multiport cal
- N-port calibration for accuracy and ease-of-measurements
- Test-set control part of PNA firmware
- 32 independent channels for fast measurement speed

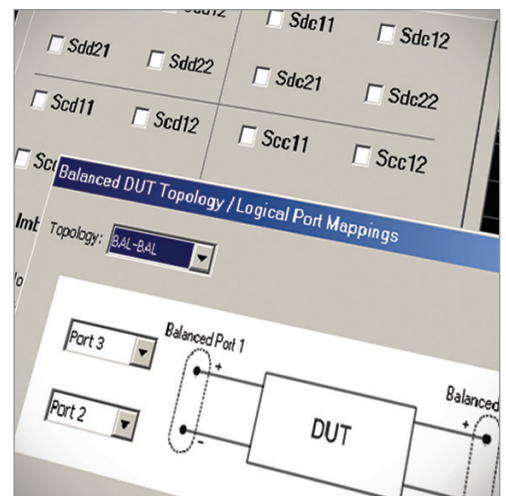

PNA – The Solution for Your Mmwave Needs

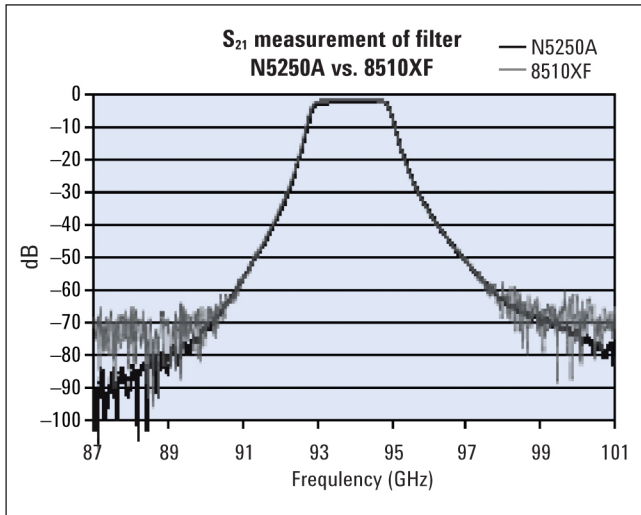

The N5250A PNA-based mmwave system has superb dynamic range. Shown here is the S₂₁ of a filter at 94 GHz, compared to the 8510XF.

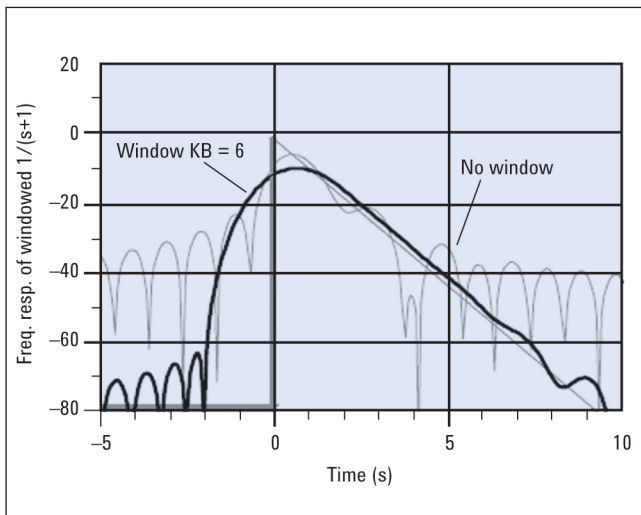

Use time domain to gate out the response of fixtures and cables, and characterize the impedance of transmission lines.

Millimeter-wave measurements

Checklist

- PNA-based 10 MHz to 110 GHz bench-top system, extendable to 325 GHz
- Compact test-heads and two built-in synthesizers, for up to 110 GHz
- Highly stable systems
- No external synthesizers to 325 GHz, when used with PNA-X
- Supported applications – pulsed-RF, antenna, and on-wafer

Time-domain analysis

Checklist

- Locate and resolve mismatches in the fixture, cable, or transmission lines
- Use gating to remove unwanted responses
- Fault-location

PNA Series Simplifies Measurements – When the Requirements are Difficult Modeling, PLTS, Antenna, Materials Test

High-frequency design and modeling

Checklist

- PNA drivers included in Connection Manager for easy connectivity
- Simple downloading of S-parameters into ADS for simulation
- Save “.s2p, .s4p, snp” files and import into ADS
- Modeling of devices using IC-CAP and PNA network analyzers

Physical Layer Test Systems (PLTS)

Checklist

- RLCG model extraction and eye-diagrams
- High-speed differential interconnect design
- Multiple aggressor differential crosstalk

Antenna measurements

Checklist



- 20,001 points per channel
- Fast measurement speed, 4.5 μ s/pt
- Forward and reverse sweeps for near-field scans
- High-sensitivity

Materials measurements

Checklist

- Measurement of dielectric and magnetic properties
- Viewing of data in real, imaginary, loss tangent, and Cole-Cole formats
- Availability of a variety of techniques to meet your materials needs

PNA-L/PNA/PNA-X Comparison Table

Device type	Required measurements	PNA-L	PNA	PNA-X
Mixers				
	Frequency-offset mode	●	●	●
	Conversion loss, isolation, and return loss	●	●	●
	Control of external source for mixer measurements	●	●	●
	Second internal source, used as LO on 2-port analyzer			●
	Second internal source, used as LO on 4-port analyzer	●		●
	Scalar calibrated converter measurements (SMC)	●	●	●
	Vector calibrated converter measurements (VMC)		●	●
	Software tuning for embedded LO		●	●
	+13 dBm output power on 2-ports (for LO)			●
	Compression, AM-PM conversion	●	●	●
Amplifiers				
	Gain, return loss, and reverse isolation	●	●	●
	Power sweep, compression, and AM-PM conversion	●	●	●
	Gain Compression Application			●
	Maximum output power level	Good	Good	Superb
	Power-sweep range for compression test	Good	Good	Superb
	Receiver compression point	Good	Good	Superb
	Internal bias-tees		●	●
	Source attenuators	● ¹	●	●
	Receiver attenuators		●	●
	Connection loop before reference path ²			●
	Connection loops for attenuators, etc.	●	●	●
	Harmonics measurements	●	●	●
	Analyzer source harmonics	Good	Good	Superb
	Intermodulation distortion	●	●	●
	Second internal source for IMD on 2-port analyzer			●
	Second internal source for IMD on 4-port analyzer	●		●
	Internal combiner for IMD testing			●
	Hot-S22	Good		Superb
	Noise figure			●
Pulsed-RF				
	Built-in pulse generator and modulators			●
	Wideband detection	Good	●	Superb
	Narrowband detection		Good	Superb
	Pulse-profile	●	●	●
	Point-in-pulse	●	●	●
	Average pulse	●	●	●
	Pulse-to-pulse	●	●	●

Legend

● : Solution available Blank : Solution not available Good and superb : Solution available, quality of solution qualified. For example, with maximum output power levels, all PNAs have output power, but the PNA-X has the highest output power.

1. 4-port PNA-L has one source attenuator. 4-port PNA-X has 4 source attenuators.
2. Applicable to high-power amplifier testing or integration of the external test equipment.

PNA – State-Of-The-Art Calibration Capabilities

High-performance ECal modules

- High-performance ECal modules, 10 MHz to 26.5 GHz, 10 MHz to 67 GHz and more
- Nine connector types, mixed-connector modules
- User characterization for adding adapters

Calibration for non-insertable devices

- Unknown through calibration
- QSOLT and n-port calibration (6-port, 8-port, 12-port, etc) for multiport test systems
- Databased-model and expanded math calibrations for highest accuracy

In-fixture measurements

- Frequency response cal, 1-port cal, 2-port cal, enhanced response-cal, TRL/TRM cal and adapter-removal cal
- An easy-to-use uncertainty calculator, and a comprehensive application note on calibration standards
- Automatic port extension removes loss and delay for in-fixture devices

Advanced mixer and amplifier calibrations

- The patented vector mixer calibration and the popular scalar-mixer calibration
- De-embedding of attenuators and the new fast source power calibration technique for amplifier measurements
- De-embedding of probes and waveguides in mixer measurements
- Unique noise figure calibration removes the effects of imperfect system source match

Learn how to set up a custom calibration kit with application note 1287-11, Specifying Calibration Standards and Kits for Keysight Vector Network Analyzers

PNA - The standard for accuracy

All the network analyzers in the PNA family are known for their high-levels of stability, contributing to accurate calibrations and measurements. With the PNA-X, users can benefit from exceptional levels of dynamic accuracy. For users in non-linear environments, the PNA's Scalar Mixer Calibration provides a higher level of measurement accuracy.

Stability of a 20 GHz PNA over a 30-hour period¹

It is clear that the more stable the hardware, the better the calibration, since it can correct the errors better. The calibration will remain stable as a function of time and temperature, and calibrations will not need to be updated as often.

Typical dynamic accuracy of a PNA-X, with -20 dBm power

If you are measuring a device with 20 dB insertion loss, the contribution of the dynamic accuracy error (receiver linearity) is less than 0.01 dB.

Scalar-mixer calibration versus a simple power meter/receiver calibration

Note the effects of mismatch that are corrected for by SMC.

110 GHz PNA drift over a 24-hour period¹

As you can see on the graph, the 110 GHz PNA drifts less than 0.7 dB, after 24 hours, at 110 GHz. Keysight's 110 GHz PNA system is the most stable mmwave system in the industry.

1. Measurements made at 25 ± 1 degree Celcius.

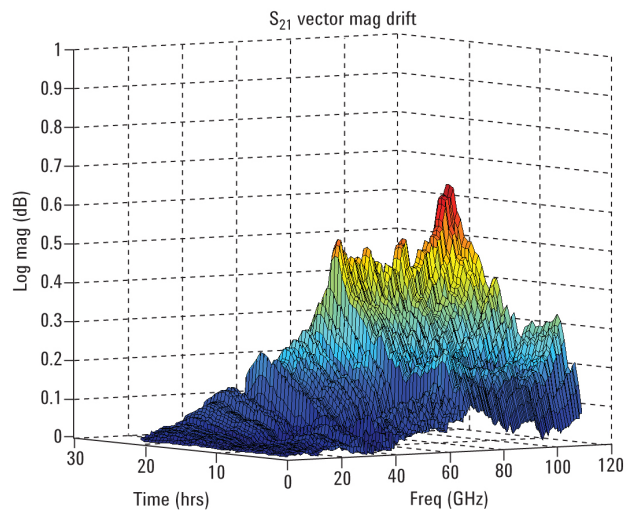
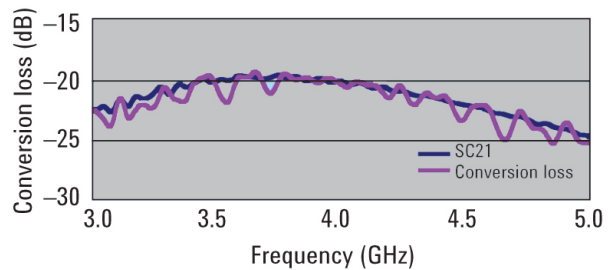
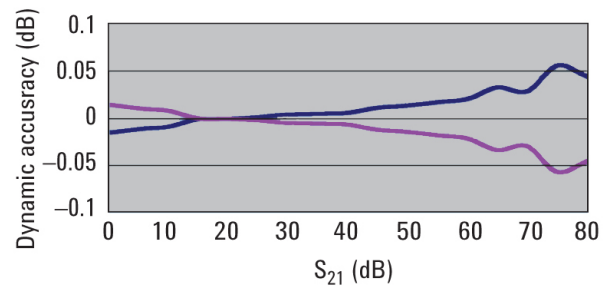
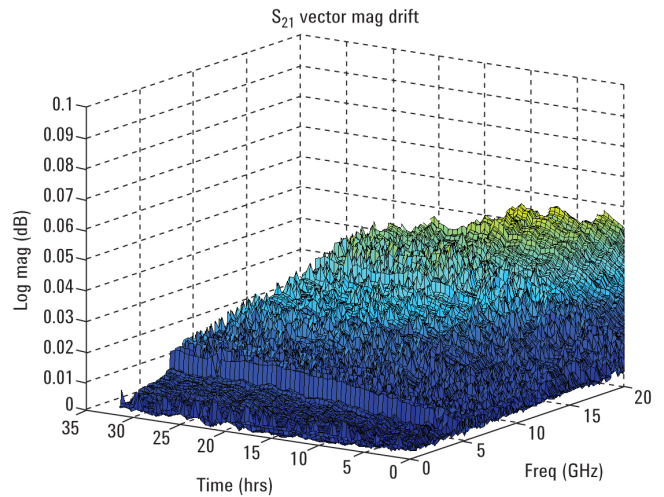

Outstanding Performance

Parameter	20 GHz 2-port PNA E8362B	20 GHz 2-port PNA-L N5230A Option 220	20 GHz 4-port PNA-L N5230A Option 240	26.5 GHz 2-port PNA-X N5242A Option 200	26.5 GHz 4-port PNA-X N5242A Option 400
Frequency range	10 MHz to 20 GHz	10 MHz to 20 GHz	300 kHz to 20 GHz	10 MHz to 26.5 GHz	10 MHz to 26.5 GHz
# of ports	2	2	4	2	4
Dynamic range ¹	123 dB	108 dB	103 dB	127 dB	127 dB
Noise floor	-120 dBm	-105 dBm	-106 dBm	-114 dBm	-114 dBm
Max output power	+3 dBm	+3 dBm	-3 dBm	+13 dBm	+13 dBm
0.1 dB compression	-5 dBm input	+6 dBm input	+9 dBm input	+12 dBm input	+12 dBm input
Trace noise	0.006 dB rms 1 kHz IFBW 0 dBm	0.006 dB rms 1 kHz IFBW -5 dBm	0.010 dB rms 100 kHz IFBW -5 dBm	0.005 dB rms 100 kHz IFBW -5 dBm	0.005 dB rms 100 kHz IFBW -5 dBm
ALC range	27 dB	23 dB	22 dB	38 dB	38 dB
Max IFBW	40 kHz	250 kHz	600 kHz	5 MHz	5 MHz
Speed	26 μs/pt	9 μs/pt	4.5 μs/pt	4.5 μs/pt	4.5 μs/pt
Display size, LCD	21.3 cm	21.3 cm	21.3 cm	26.4 cm	26.4 cm
Touch screen	No	No	No	Yes	Yes

1. 20 GHz, test port, 10 Hz IFBW.

Parameter	40 GHz PNA-L N5230A Option 420	40 GHz PNA E8363B
Frequency range	10 MHz to 40 GHz	10 MHz to 40 GHz
Dynamic range	123 dB	108 dB
Noise floor	-120 dBm	-105 dBm
Max output power	+3 dBm	+3 dBm
0.1 dB compression	-5 dBm input	+6 dBm input
Trace noise (1 kHz)	0.006 dB rms 1 kHz IFBW 0 dBm	0.006 dB rms 1 kHz IFBW -5 dBm
ALC range	27 dB	23 dB
Max IFBW	40 kHz	250 kHz
Speed	26 μs/pt	9 μs/pt

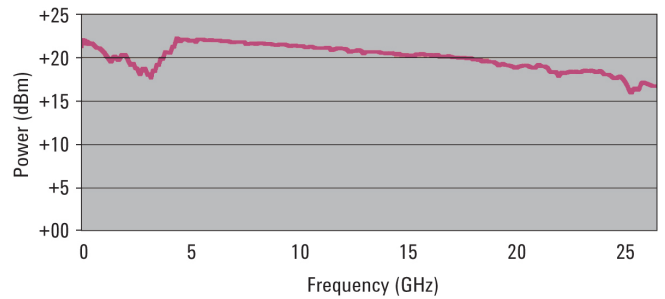
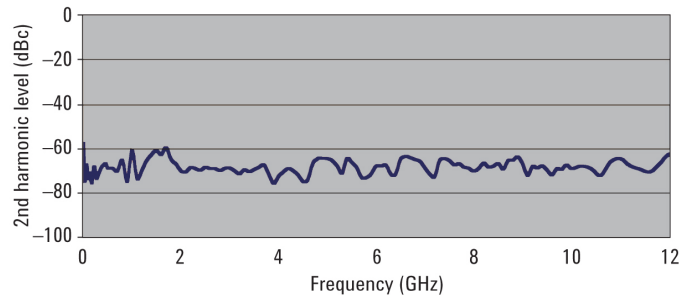

Completing The Solution

Protect confidential data

The best method for maintaining security is to remove the hard disk drive. The PNA provides the removable hard disk drive as a standard feature, enabling you to easily remove the drive and keep it safe in a secure area.

Protect your software investment

Keysight protects your 8753, 8720 and 8510 software investment by providing migration tools to reduce your code conversion effort.

www.keysight.com/find/nadisco

Network analyzer forum

Visit the online network analyzer discussion forum where you can learn how your peers are solving some of their most challenging measurement problems.

www.keysight.com/find/agilent_naforum

Free CD - Network analyzer application notes and video demos

Application topics include amplifiers, mixers/converters, pulsed-RF, millimeter/sub millimeter-wave, and materials measurements.

www.keysight.com/find/naccd



Web Resources

Visit our Web sites for additional product information and literature.

PNA-X microwave network analyzers

www.keysight.com/find/pna-x

PNA-L microwave network analyzers

www.keysight.com/find/pnal

PNA microwave network analyzers

www.keysight.com/find/pna

ENA RF network analyzers

www.keysight.com/find/ena

Physical layer test systems

www.keysight.com/find/plts

Multiport test solutions

www.keysight.com/find/multiport

Antenna test

www.keysight.com/find/antenna

Electronic calibration (ECal) modules

www.keysight.com/find/ecal

RF and microwave accessories

www.keysight.com/find/accessories

Mechanical and electronic calibration

kits and pulsed-RF measurements

www.keysight.com/find/pulsedrf

Keysight RF & microwave network

analyzer calibration resources

www.keysight.com/find/nacal

RF and microwave network analysis and impedance probings

www.keysight.com/find/probingrf

Materials measurements

www.keysight.com/find/materials

Balanced measurements

www.keysight.com/find/balanced

Evolving Since 1939

Our unique combination of hardware, software, services, and people can help you reach your next breakthrough. We are unlocking the future of technology.

From Hewlett-Packard to Agilent to Keysight.

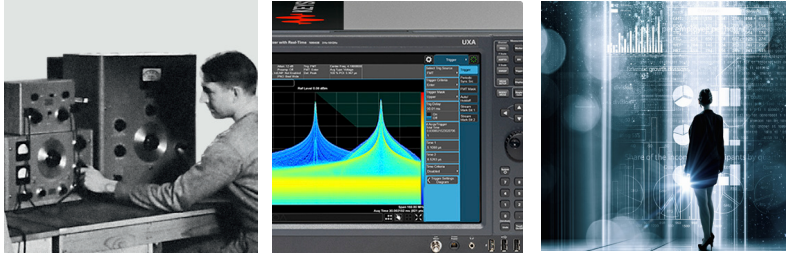

For more information on Keysight Technologies' products, applications or services, please contact your local Keysight office. The complete list is available at: www.keysight.com/find/contactus

Americas

Canada	(877) 894 4414
Brazil	55 11 3351 7010
Mexico	001 800 254 2440
United States	(800) 829 4444

Asia Pacific

Australia	1 800 629 485
China	800 810 0189
Hong Kong	800 938 693
India	1 800 11 2626
Japan	0120 (421) 345
Korea	080 769 0800
Malaysia	1 800 888 848
Singapore	1 800 375 8100
Taiwan	0800 047 866
Other AP Countries	(65) 6375 8100

Europe & Middle East

Austria	0800 001122
Belgium	0800 58580
Finland	0800 523252
France	0805 980333
Germany	0800 6270999
Ireland	1800 832700
Israel	1 809 343051
Italy	800 599100
Luxembourg	+32 800 58580
Netherlands	0800 0233200
Russia	8800 5009286
Spain	800 000154
Sweden	0200 882255
Switzerland	0800 805353
	Opt. 1 (DE)
	Opt. 2 (FR)
	Opt. 3 (IT)
United Kingdom	0800 0260637

For other unlisted countries: www.keysight.com/find/contactus (BP-9-7-17)

DEKRA Certified
ISO 9001 Quality Management System

www.keysight.com/go/quality
Keysight Technologies, Inc.
DEKRA Certified ISO 9001:2015
Quality Management System

myKeysight

myKeysight

www.keysight.com/find/mykeysight

A personalized view into the information most relevant to you.

http://www.keysight.com/find/emt_product_registration

Register your products to get up-to-date product information and find warranty information.

KEYSIGHT SERVICES

Accelerate Technology Adoption.
Lower costs.

Keysight Services

www.keysight.com/find/service

Keysight Services can help from acquisition to renewal across your instrument's lifecycle. Our comprehensive service offerings—one-stop calibration, repair, asset management, technology refresh, consulting, training and more—helps you improve product quality and lower costs.



Keysight Assurance Plans

www.keysight.com/find/AssurancePlans

Up to ten years of protection and no budgetary surprises to ensure your instruments are operating to specification, so you can rely on accurate measurements.

Keysight Channel Partners

www.keysight.com/find/channelpartners

Get the best of both worlds: Keysight's measurement expertise and product breadth, combined with channel partner convenience.

www.keysight.com/find/pna



This information is subject to change without notice.
© Keysight Technologies, 2017
Published in USA, December 1, 2017
5989-6014EN
www.keysight.com